

MOLDED SWITCH

Vernexx, LLC is an authorized Distributor
for **OKI Reed Switches**

RA-901

Miniature SMD

■ GENERAL DESCRIPTION

The RA-901 is a molded switch made by molding the glass tube of ORD228VL with resin and processing the leads. It ensures ease of handling of the switch while maintaining the excellent characteristics of ORD228VL.

■ FEATURES

- (1) It has a gull wing shape lead suitable for SMT.
- (2) Automatic mounting of component by tape and reel feed is possible.
- (3) It features enhanced shock resistance characteristics due to resin mold that protects the glass tube.
- (4) General Purpose Miniature

■ EXTERNAL DIMENSIONS (Unit: mm)

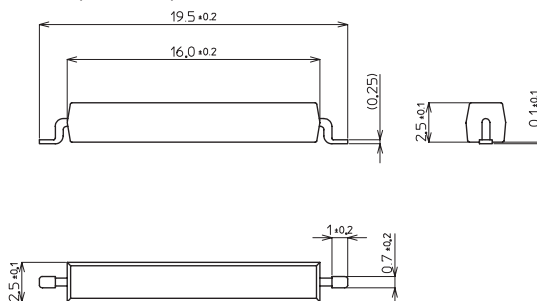

■ PAD LAYOUT SAMPLE



■ APPLICATIONS

- Automotive electronic devices
- Control equipment
- Communication equipment
- Measurement equipment
- Household appliances

■ SPECIFICATION

Contact form	1A
Pull-in value (PI)	15~49AT
Drop-out value (DO)	10AT (Min.)
Contact resistance (CR)	100mΩ (Max.)
Contact rating	10W (Max.)
Maximum switching voltage	100V
Maximum switching current	0.5A
Maximum carry current	1.0A
Breakdown voltage	200V (Min.)
Insulation resistance	$1 \times 10^9 \Omega$ (Min.)
Operate time	0.4ms (Max.)
Bounce time	0.3ms (Max.)
Release time	0.05ms (Max.)
Shock resistance	50G—11ms
Vibration resistance	50G (10~2000Hz)
Operating temperature range	-40~125°C
Storage temperature range	-50~125°C

■ PULL-IN VALUE TABLE

Model No.	1	2	3	4	5	6	7	8
Pull-in value (AT)	15~34	18~36	19~39	21~42	24~45	27~49	30~49	34~49

■ ENVIRONMENTAL CHARACTERISTICS

(1) Temperature cycle

(-55°C ~ +125°C)

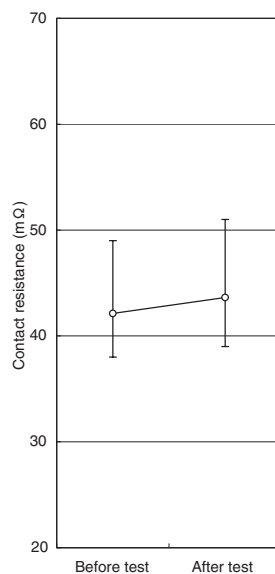
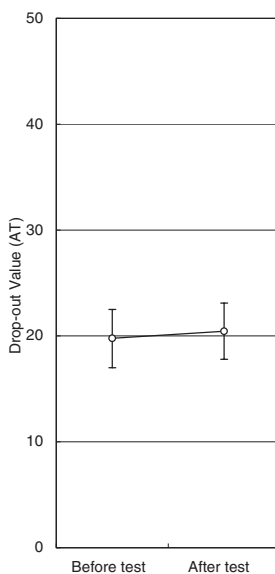
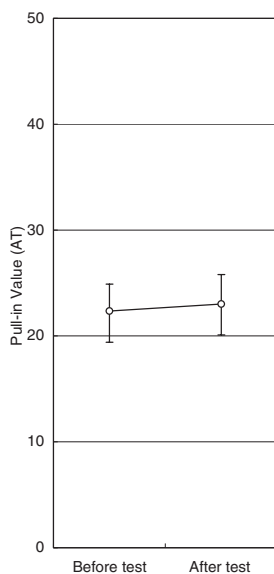

(2) Temperature and humidity cycle

(-10°C ~ +65°C 80% ~ 98%)

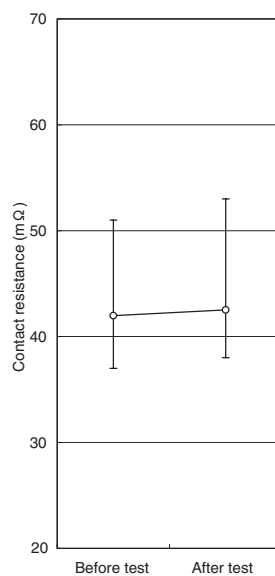
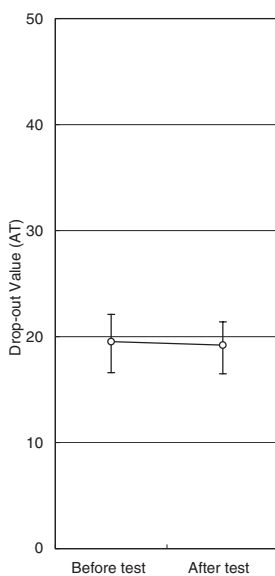
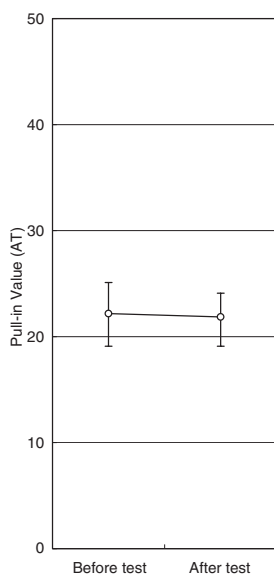

3

(3) High temperature storage test (125°C 500H)

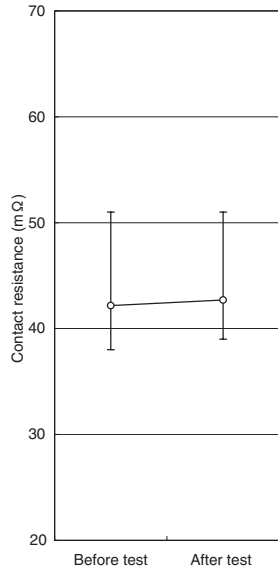
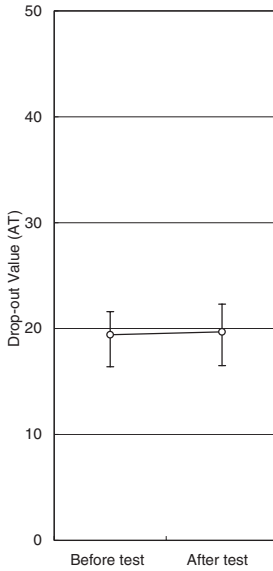
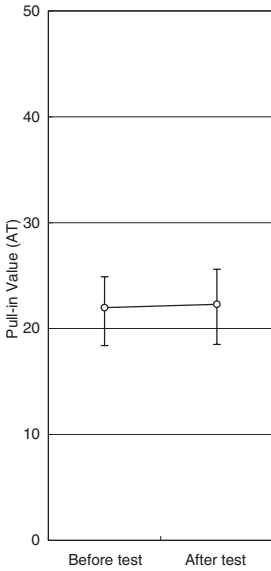

(4) Low temperature storage test (-40°C 500H)

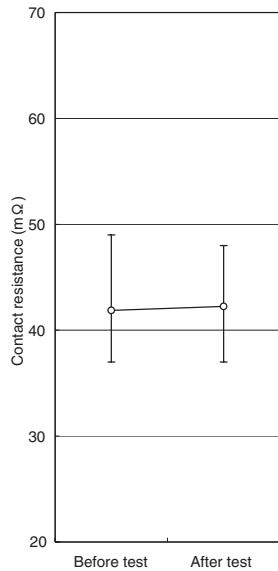
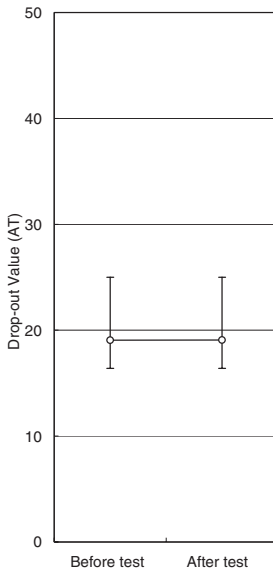
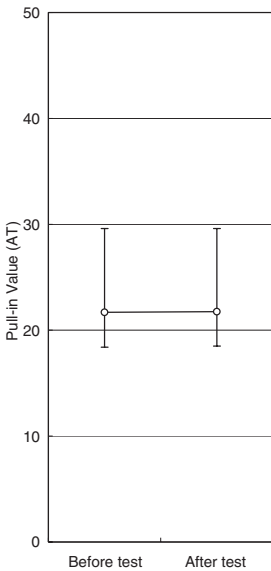

(5) Shock test

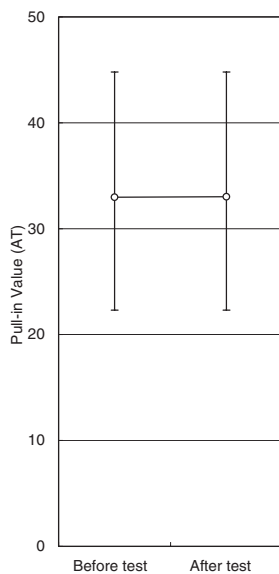

(50G 11msec)

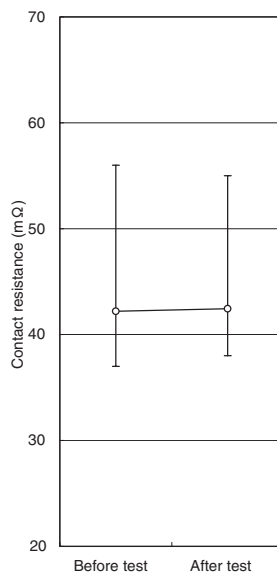
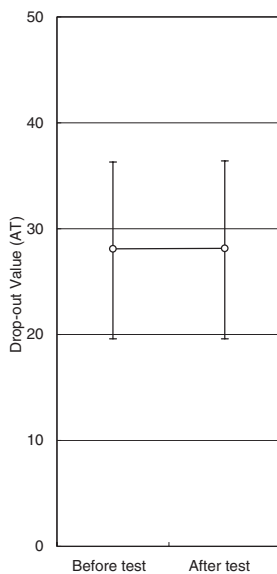

(6) Vibration test

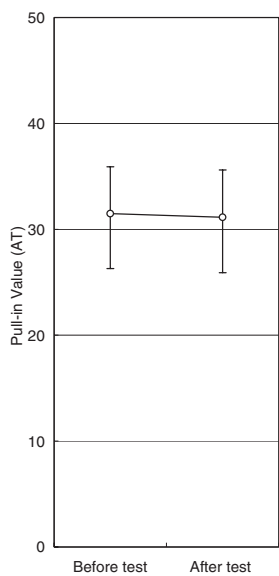

(50G 10~2000Hz)

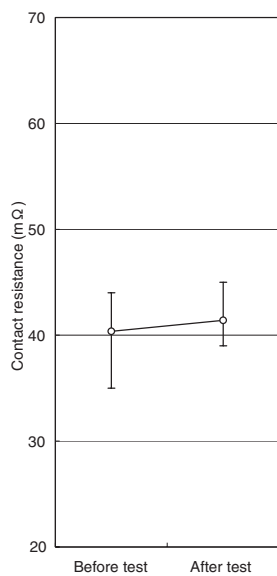
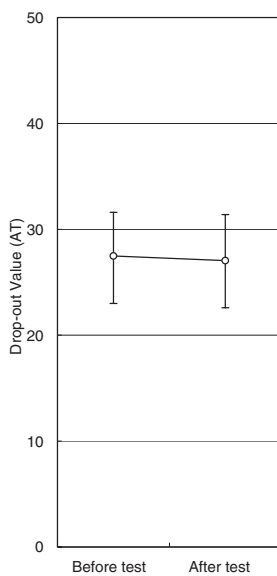

(7) Shock Resistance test

(ϕ 10mm steel ball free fall impact height 230 mm)

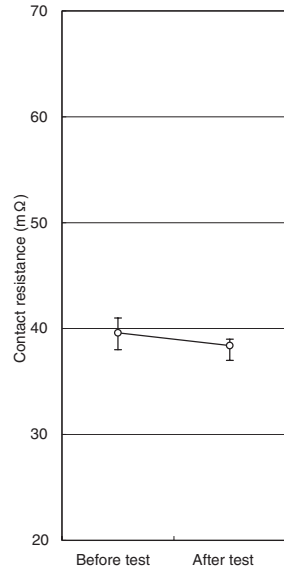
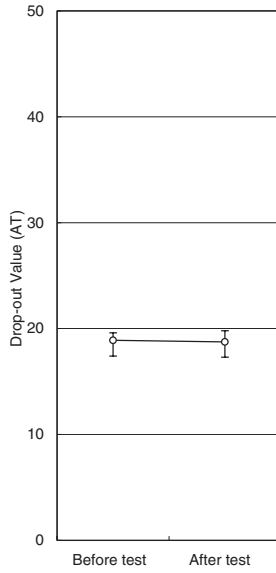
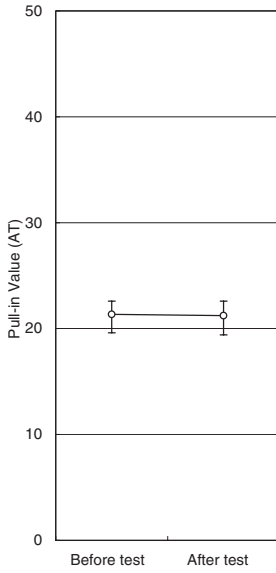

3